

Technical data sheet



Product features

Open stand mobile 33x51

Model

SAP Code

00003158



– Material: Stainless steel

Technical data sheet



Technical drawing

Open stand mobile 33x51

Model

SAP Code

00003158

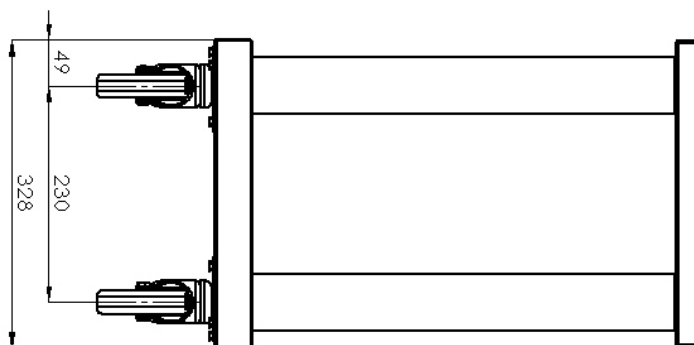
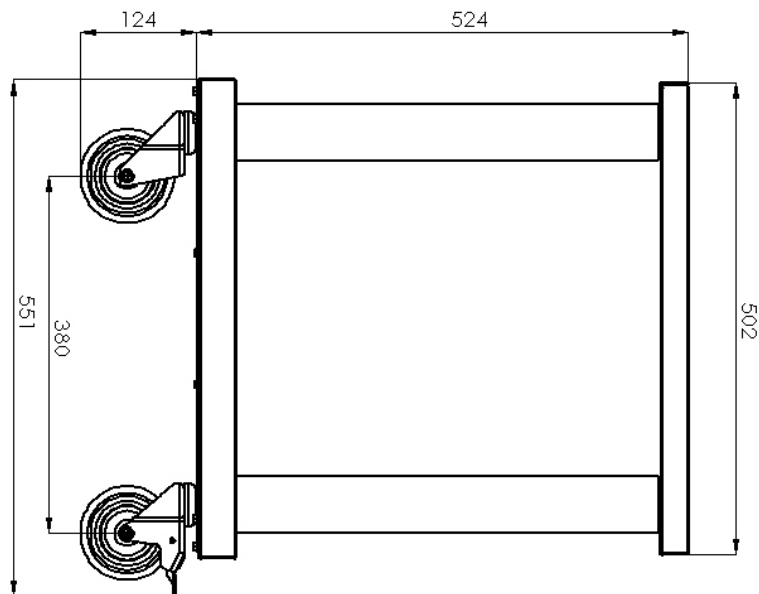

Technical data sheet



Technical parameters

Open stand mobile 33x51

Model

SAP Code

00003158

1. SAP Code:

00003158

6. Gross Width [mm]:

340

2. Net Width [mm]:

330

7. Gross depth [mm]:

520

3. Net Depth [mm]:

510

8. Gross Height [mm]:

660

4. Net Height [mm]:

650

9. Gross Weight [kg]:

11.00

5. Net Weight [kg]:

9.50

10. Material:

Stainless steel